

MODELO T-2

[CARACTERÍSTICAS]

- Dimensiones:

Largo: 75,9 cm

Ancho: 32,0 cm

Alto: 73,6 cm

- Accesorios:

Huevo púas: x1

Cejillas: x2

Cable: x2

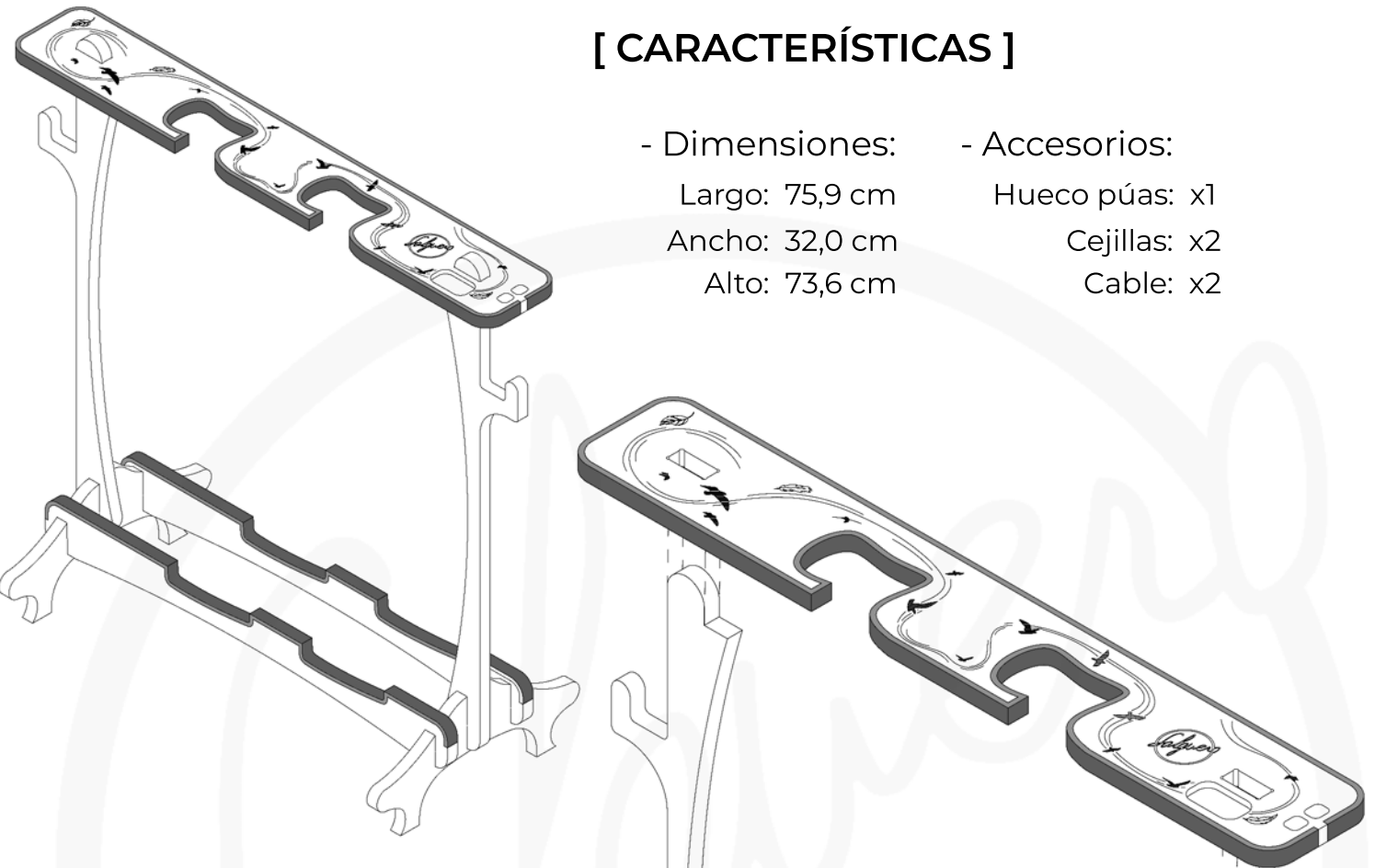

[PIEZAS]



x1



x2



x2



x2

